



SAILOR A1 VHF-DSC Operating Instructions

Distress Call, see page ii. Contents, see page 1.

DISTRESS Call

Quick DSC DISTRESS Call



1. If off or UNIT OFF: press ON/OFF.



2. Hook off the handset.

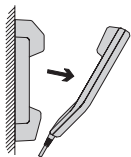

3. Send DSC distress call.

Open DISTRESS lid and press DISTRESS on hook until RELEASE is displayed. This takes 5 seconds, during which the indicator lamps TX and ALARM will flash.

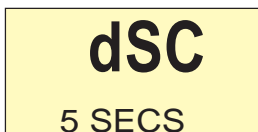

5-4-3-2-1-RELEASE

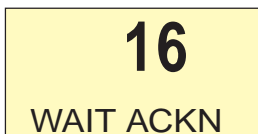

Wait for answer!

(The distress call is repeated automatically every 3.5-4.5 minutes until acknowledgment is received or stopped manually from the unit.)

Acknowledgment

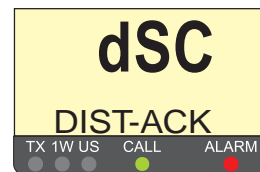

4. To VIEW the call, press

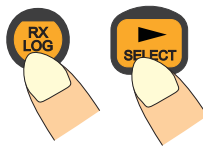

Mayday Procedure

5. To enter VHF mode press "16":



6. Lift handset if on hook.

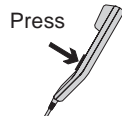

Pressing PTT, say:

"MAYDAY"

"This is"

- the 9-digit identity and the call sign or other identification of the ship,
 - The ship's position,
 - The nature of distress and assistance wanted,
 - any other information which might facilitate the rescue.
- "OVER."

Release PTT and listen for answer.



NB! DISTRESS is only to be used in case of an emergency!

Handset

What is What?

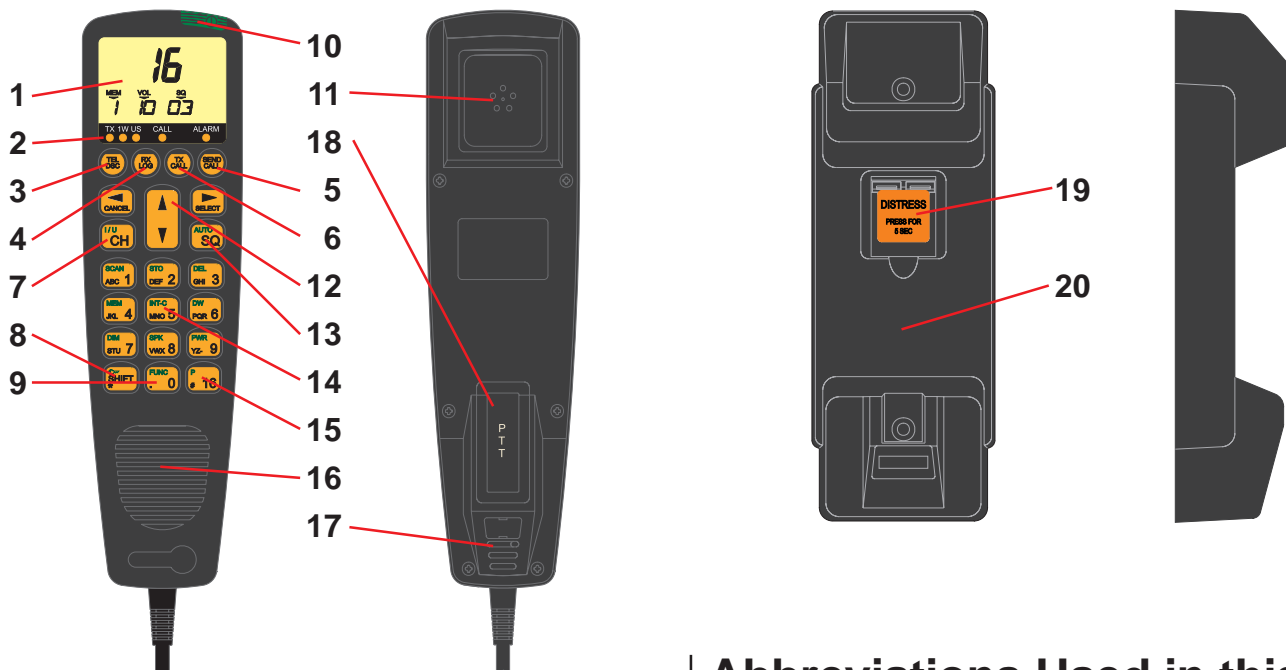

- | | |
|------------------------|-----------------------------|
| 1. Display | 8. Shift key |
| 2. Indicator lamps | 9. FUNC key |
| TX | 10. ON/OFF button |
| 1W | 11. Earpiece |
| US | 12. Volume control |
| (For information on BI | 13. Squelch selection |
| version, see page 10) | 14. Intercom |
| CALL | 15. Channel 16 quick select |
| ALARM | 16. Loudspeaker |
| 3. TEL/DSC | 17. Microphone |
| 4. RX/LOG | 18. PTT key |
| 5. SEND CALL | 19. Distress button |
| 6. TX CALL | 20. 25W key |
| 7. Channel selection | (US versions only) |

Abbreviations Used in this Manual

ADDR	Address
ATIS	Automatic Transmitter Identification System
BI	Channel Mode used when sailing on European rivers (details on p. 10)
CU	Control Unit
DSC	Digital Selective Calling
DUP	Duplex
DW	Dual Watch
GMDSS	Global Maritime Distress and Safety System
GPS	Global Positioning System
LF	Low Frequency
MEM	Memory
MMSI	Maritime Mobile Service Identity
MSG	Message
PTT	Push-To-Talk (talk button)
RX	Receive(r)
SQ	Squelch
STN	Station
TEL	Telephony
TX	Transmit(ter)
UTC	Coordinated Universal Time

Introduction

For more than half a century, Sailor has been synonymous with high-quality maritime communication equipment.

When it comes to making use of the very latest technology, S. P. Radio is at the forefront. We are ready for the future, both technologically and commercially, and will continue to supply top-quality equipment for global communication in the years to come.

S. P. Radio's experience in maritime safety and communication is extensive; the company has built as many as 250,000 VHF units, mainly for the professional market. One of the main reasons for this huge success is continual product development, which makes it possible for us to offer products that are truly excellent in terms of quality, sturdiness, ease of operation, and compact design.

The SAILOR A1 Basic and A1 DSC are part of the new SAILOR System 4000. This is a full range of maritime communication equipment developed to increase safety and ease communication for all kinds of vessels: leisure boats, fishing vessels, cargo ships, and cruise liners.

As our central concern is fast and professional service, we have introduced the SAILOR Certified Service Centre (CSC) concept. This, we feel, is the ultimate way of ensuring a high level of service, continuously monitored and adjusted.

Today S. P. Radio is the leading VHF supplier in the world, represented in 90 countries around the world. Consequently we are able to service your SAILOR VHF equipment in the best way possible. No matter where.

About this Manual

This manual is for the daily user of the system. The manual includes two main sections, "basic" operation and "full" operation. The basic part offers a short easily-read description of the main functions; the full part offers elaborate descriptions of the functions of the product.

Please note

Any responsibility or liability for loss or damage in connection with the use of this product and the accompanying documentation is disclaimed. The information in this manual is furnished for informational use only, is subject to change without notice, may contain errors or inaccuracies, and represents no commitment whatsoever. This agreement is governed by the laws of Denmark.

Doc. No.: B4901GB0

Issue: H/0140



SAILOR® · Porsvej 2 · PO Box 7071 · DK-9200 Aalborg SV · Denmark
Phone: +45 9634 6100 · Fax: +45 9634 6101 · Telex: 69789 ECI DK
E-mail: sailor@sailor.dk · Web: www.sailor.dk

Contents

DISTRESS Call	ii	Setting up a Call from Extended Menu	20
Quick DSC DISTRESS Call	ii	TX CALL Menu Tree	23
Acknowledgment	ii	Function Menu	24
Mayday Procedure	ii	Function Menu Item Description	26
Handset	iii	FUNCTION Menu Tree	28
What is What?	iii	Directory Setup	29
Abbreviations Used in this Manual	iii	ADDR BOOK Setup	31
Introduction	iv	VHF System Description	32
About this Manual	iv	International Channels	33
Telephony Display	2	US Channels	34
Handset Main Function Keys	2	BI Channels	35
Basic Operation	3		
Switching ON/OFF	3		
Basic Telephony Operation	3		
Listening for Telephony Calls	3		
Receiving a Telephony Call	4		
Making a Telephony Call	4		
Channel Control	5		
Squelch Control	5		
Setting the Volume Level	6		
Muting the Speaker	6		
Setting Transmitter Power Level	6		
Dimmer Function	6		
Basic DSC Operation	7		
Receiving an Individual DSC Call	7		
Transmitting DSC Call to a Ship Station	7		
Transmitting DSC Call to a Shore Station	8		
Full Operation	10		
Full VHF Telephony Operation	10		
Setting Channel Mode	10		
Setting International/US Channel Mode	10		
Setting International/BI Channel Mode	10		
25W Transmitter Power Level	10		
Setting Memory Scan Table	11		
Scanning of Channels	11		
Dual Watch	13		
Keyboard Lock	14		
Intercom	14		
Full DSC Operation	16		
Receiving DSC Calls	16		
Tone signalling when receiving DSC Calls	17		
RX LOG Menu	17		
The RX LOG Menu Tree	18		
TX CALL Menu	20		

Telephony Display

Normal display

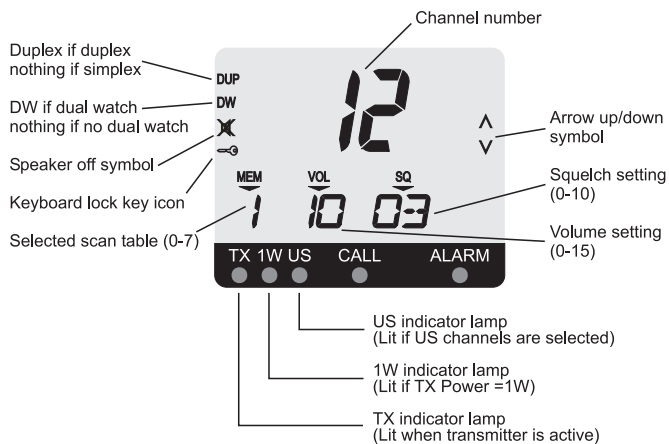

Scanning display

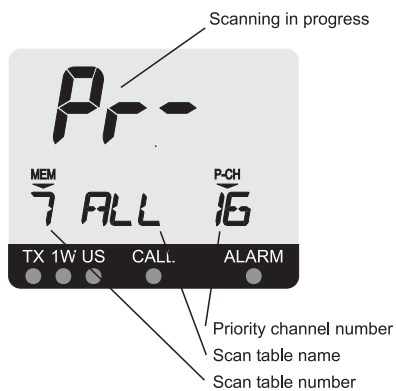

Handset Main Function Keys



ON/OFF key.

Turns the handset on or off.



TEL/DSC key.

Changes handset operation mode:
Toggles between handset DSC mode and handset TELEPHONY mode.



RX LOG key.

Enters DSC menu to read received DSC messages.



TX CALL key.

Enters DSC menu to set up DSC calls for transmission.



SEND CALL key.

Starts transmission of set up DSC call.



CANCEL key.

If a DSC call is in progress, it cancels transmission of the call.
If handset in DISTRESS REPEAT mode, it cancels the distress call.



"16" key.

Selects TELEPHONY mode and channel 16.



Function menu.

Enters the function menu to set up the handset and system.
If function menu is active it enters VHF telephony mode.

After 5 minutes of inactivity the handset will resume in telephony mode by default.

Basic Operation

Switching ON/OFF

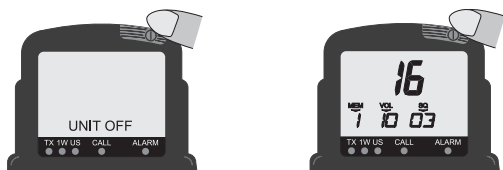

To switch on the handset unit, push the ON/OFF button on the handset.

If the handset unit is off, the display is blank or shows “UNIT OFF” to indicate that the system is operated from another control unit.

To switch off the handset unit, push the ON/OFF button on the handset for at least 1 second.

Basic Telephony Operation

To activate the VHF functions if not active press the key TEL/DSC or the key “16”.



Listening for Telephony Calls

According to international rules, all ships shall monitor channel 16 constantly:

1. Select channel 16 by pressing:

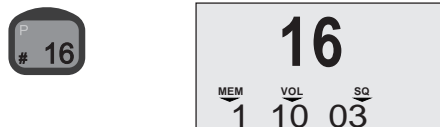

2. Set the squelch level by means of the buttons

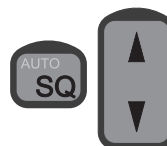

- a. Step down squelch level until noise is heard on free channel.
- b. Then step up to the first level where just silent.

(To listen for calls on other channels, select the channel number or use the scanning facility.)

Receiving a Telephony Call

When a call comes in, and your call name is heard in the loud-speaker:

1. Hook off the handset.
2. Press the PTT key on the handset.



3. To answer the call, say:
“<The name of the calling station>
This is <Your station name>”

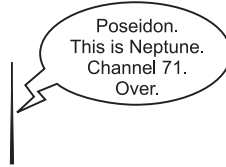

4. To suggest channel, say:
“Channel <suggested channel number>”

5. Say “over” and release the PTT key to let the caller accept the proposed channel number.



6. Switch to the channel agreed upon (for example channel 71) and communicate:



For short-distance communication, use 1W.

Press the PTT key when talking only. If on a simplex channel, say “over” every time you have completed talking.

Making a Telephony Call

In telephony mode:

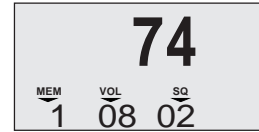

1. Select channel 16 or another channel specified or agreed upon:



2. Hook off the handset.

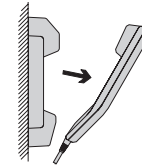

3. When speaking, press the handset PTT key.



Make the call:

1. <Called station name (3 times)>
2. “This is “
<Your station name (3 times)>
3. “Over”

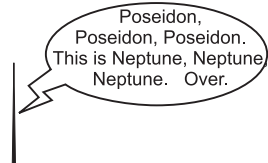

4. Release the PTT key to listen.



5. When answered, agree upon a channel, switch to the channel (for example channel 6) and communicate.



Press the PTT key when talking only. If on a simplex channel, say “over” every time you have completed talking.

Channel Control

Setting the VHF channel can be done in three ways by means of the numeric input keys (sequentially) or by means of the function “next channel up/down”, or by using the quick select key “16”:

Numeric keys:

Press the numeric input keys (sequentially) until the desired channel number is shown on the handset display:



Ex:

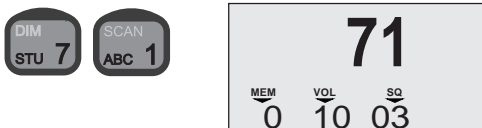

If private channels are available in your VHF system, a private channel number is selected by pushing the buttons:

Ex: Private channel 23

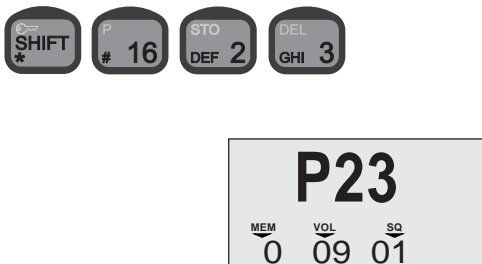

Next channel function:

To select the next channel up or down (starting point is displayed channel).



The next channel function is active until the key is released again, toggling through the channels as long as pushed.



Quick select key:

Press the key



Squelch Control

Manual squelch level setting:

Set the squelch sensitivity of the receiver by buttons

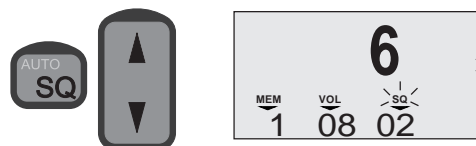

Press  for more than 4 seconds and the squelch level goes

up/down automatically.

The squelch setting is shown on the display below the “SQ” symbol.

Automatic squelch level setting:

The VHF system automatically sets the optimal squelch level to mute the background noise level.

To set squelch level automatically:



Setting the Volume Level

Setting the volume level can be done both for the speaker and the earpiece individually. (The setting can be 0-15).

The volume level of the speaker can be controlled when handset is on hook, or the speaker is set to be active when handset is hooked off. The volume level of the earpiece can be controlled when the handset is hooked off, and the speaker is not set to be active when handset is hooked off. The volume setting for the earpiece can also be set in the function menu.

If the speaker is active the speaker setting is always shown on the display. Only when the handset is hooked off and the speaker is not set to be active, is the volume level of the earpiece shown.

To change the volume setting use

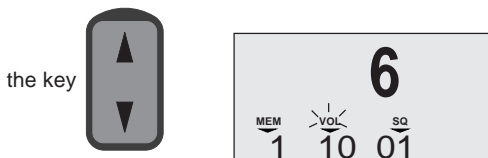

Press the key for more than 1 second and the volume level goes up/down automatically (until the volume limit is reached).

Muting the Speaker

If the speaker is active the handset automatically mutes the speaker when the PTT is pressed, and then reactivates the speaker when the PTT is released.

The speaker icon on the display shows the speaker state.

Speaker active:

To mute the speaker, press:

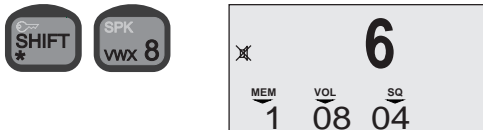

Speaker muted:

To reactivate the speaker, press:

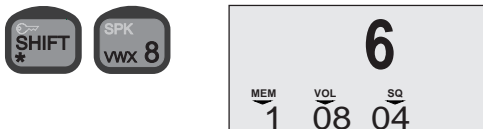

Setting Transmitter Power Level

The handset can control the transmitter power level, which can be set to either 1W or 25W.

Low power 1W is indicated by the indicator lamp on the display. Some channels may be programmed to operate at 1W level only.

To change the TX power level press

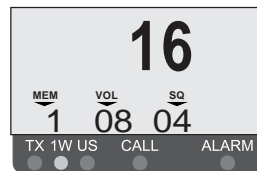



1W indicator lamp

Dimmer Function

The handset features display backlight, keyboard backlight and light in the indicator lamps (TX, 1W, US, CALL and ALARM). The light can be set at four steps 0-3.

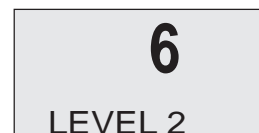
To change the dimmer level:



When the key  is being pressed the dimmer level will change every second.

Basic DSC Operation

When switched on, your VHF set is constantly monitoring channel 70 for incoming DSC calls.

Receiving an Individual DSC Call

When a DSC call is received the handset will notify you according to the kind of DSC call received.

When receiving an individual call including VHF working channel proposal, the following will happen (VHF working channel: 8):
The handset will notify you by showing the "DSC call received" display, the call indicator lamp will flash and the loudspeaker will announce the call.

1. DSC call received:

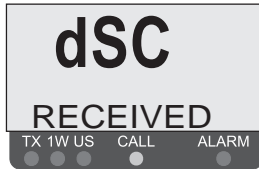

The lower part of the display will toggle the information:

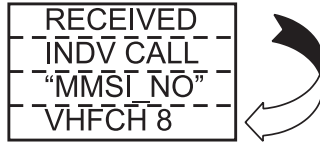

2. Hook off the handset to transmit a DSC acknowledgment call to connect to the initiating party on the proposed VHF working channel.

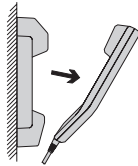

3. When acknowledgment has been transmitted the handset automatically switches to telephony mode, ready for VHF communication on the proposed channel.



4. Start communication as normally done in telephony mode.

Transmitting DSC Call to a Ship Station

To set up and transmit an individual DSC call and propose a working channel:

1. Press TX CALL.



2. Press arrow right.



3. Key in the nine digit MMSI number of the ship station to be called. Use the keys:



4. To select the MMSI number:
Press arrow right.



5. To transmit the DSC call:
Press SEND CALL.



When the call has been transmitted the display will show the message:



Transmitting DSC Call to a Shore Station

To set up and transmit a public call to a shore station for VHF connection:

1. Press TX CALL.



2. Press arrow up twice.



3. Press arrow right.



4. Key in the nine digit MMSI number of the shore station to be called. Use the keys:



5. To select the MMSI number:
Press arrow right.



6. To enter telephone number:
Press arrow up.



Press arrow right.



7. Key in the digits of the phone number to be called.
Use the keys:



8. To end the phone number input press arrow right twice.



9. To transmit the DSC call:



Press

When the call has been transmitted, the display will show the message:



Full Operation

Full VHF Telephony Operation

Setting Channel Mode

Some VHF radios offer a choice between two sets of channels, called channel modes. If your VHF features two modes, you can either switch between international/US channels, or between international/BI channels.

International mode is used when sailing on any sea in the world, except in US waters.

US mode is used when sailing in US waters.

BI mode is used when sailing on the rivers of Europe.

Setting International/US Channel Mode

If your VHF features the choice of international/US mode, switching between those two sets of channels is done by pressing the keys:

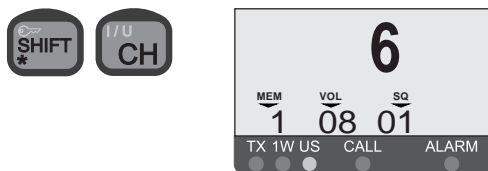

Channel mode indication

When US mode is selected, the yellow US indicator lamp is lit. Otherwise, the radio is in international mode.

Setting International/BI Channel Mode

If your VHF features the choice of international/BI mode, switching between those two sets of channels is done by pressing the keys:

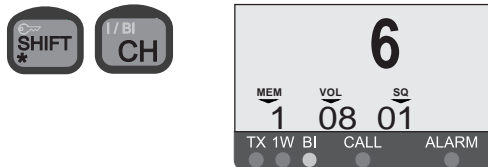

Channel mode indication

When BI mode is selected, the yellow BI indicator lamp is lit. Otherwise, the radio is in international mode.

When BI mode is selected, ATIS is activated automatically.

25W Transmitter Power Level

NB! For US channels 13 and 67.

If the VHF is programmed with the set of US channels, some of those channels are specified to be used only with the limited transmitter power level of 1W. This means that the TX power level cannot be changed to 25W as described.

However, it is still possible to set the TX power level to 25W by using:

The TX power level of 25W is only active while the key is being pressed down; when the key is released the TX power level is again reduced to 1W.

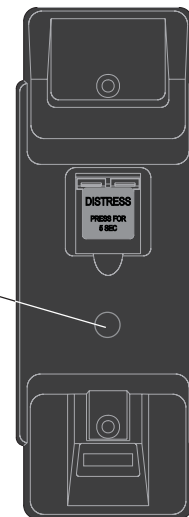

Setting Memory Scan Table

The VHF 4000 system has eight independent sets of memory tables to save channels for making scanning sessions. Each memory table may contain all channels available in the system.

To distinguish between the tables, each table has a number (0-7) and to each number can be attached a name of maximum seven characters.

To attach a name to a scan table, enter the function menu.

(See the section 'Funktion Menu').

The scan table number selected is shown in the left corner of the handset display.



Pre-programmed memory tables for scanning of channels:

Table 6: Channels for intership communication.

Table 7: All channels in system.

It is recommended not to alter the pre-programmed channels in scanning tables 6 and 7. These scanning tables are used to search for channels for intership DSC communication, and altering the channels may exclude you from performing intership communication on certain channels.

Setting the selected scan table:

To set the selected scan table to be number 0:

1. Press  



The handset display shows the message "SEL"ect and the MEM symbol flashes. The lower part of the display shows the scan table's number and name.

2. Press 

The display now shows the new scan table number 0.



Scanning of Channels

To start scanning:

- Press  

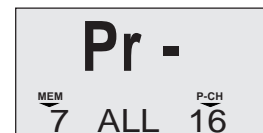

The lower part of the display shows from left to right: scan table number, scan table name, priority channel of scan table.

If scan table contains no channels, no scanning will be started, and the display will show the following message:

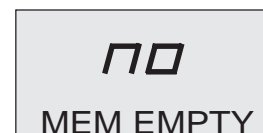

To stop scanning:

Scanning in progress can be terminated in the following ways:

1. Press  

The system resumes normal VHF operation on the channel selected before the scanning session was initiated.

2. Press 

The system resumes normal VHF operation on quick select channel "16".

3. Hook off the handset.

The system resumes normal VHF operation on the channel selected before the scanning session was initiated.

4. Push the PTT

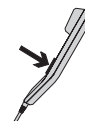

If no signal has been detected on any channel, the system resumes normal VHF operation on the channel selected before the scanning session was initiated. If a signal has been detected on a channel, the system resumes normal VHF on the last channel where signal was detected.

If scanning is in progress and a signal is detected on eg. channel 6, the display changes to show the selected channel number and volume level.

When a priority scanning is in progress, channel 16 is scanned once for every channel scanned in the scan table. Channel 16 cannot be deleted or excluded while a scanning is in progress.



To add a channel to a scan table:

Select channel number (shown on the display), and then press



Ex: To add channel 6 to scan table number 1:

1. Press Channel 6 is selected.



2. Press The message "stores channel" is shown for two seconds.



To delete a channel from a scan table:

Select channel number (shown on the display), and then



Ex: To delete channel 6 from scan table number 1:

1. Press Channel 6 is selected.

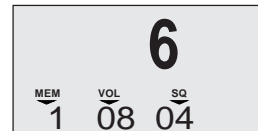

2. Press The message "delete channel" is shown for one second.



Then the display will show the next channel in the scan table.



If there are no more channels in the scan table and deletion is attempted, the display will show the message "mem empty".



To view contents of channels in a scan table:

Viewing which channels a specific scan table contains, can be done in two ways:

While the key is being pressed down, the display will step through the channels of the scan table selected.

1. Press  , the latter for 1 second.

OR

2. Press  , the latter for 1 second.



Dual Watch

The handset may perform a dual watch of channels, a priority channel and the selected channel being monitored simultaneously.

To start a dual watch with channel 6 and priority channel 16:

Select channel 6.

Then press



When a dual watch is in progress, "DW" appears in the top left corner of the display and the priority channel is shown in the bottom right corner of the display.

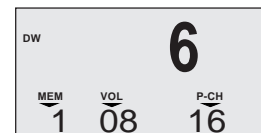

To stop a dual watch: When a dual watch is in progress it can be terminated in three ways.

1. Press  

2. Push PTT

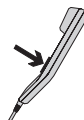

The system resumes VHF on the selected channel 6 and starts transmitting.

3. Push 

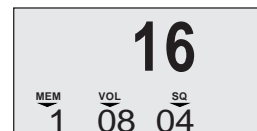



The system resumes VHF on the quick select channel (normally 16).

Keyboard Lock

The handset has a keyboard lock, which locks some keys to avoid unintentional channel changes during a telephony session. When the keyboard is locked the only functions that can be controlled are:

1. Setting the volume level.
2. Setting the squelch level.
3. Channel up/down.

To lock the keyboard:

Press   (second time, press for 1 second).



The key symbol appears, indicating that the keyboard is locked.

Unlocking the keyboard can be done in two ways:

1. Press  

The keyboard is unlocked.

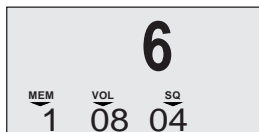

2. Press  for 1 second.

The keyboard is unlocked and channel 16 selected.



Intercom

If your VHF system has more than one control unit, it is possible to carry out an intercom between two control units. When the intercom feature is used the handset will perform as follows:

Initiating an intercom from the handset to another control unit: To call another control unit:

1. Press  



This display indicates that the handset expects an input of the location number to be called.

2. Press a numeric key to choose location to be called



Ex: 

3. If location 2 is NOT available, the display shows

and no dialling is carried out.



If location 2 is available the display shows

and a ringing tone is heard in the speaker/earpiece.



This indicates that a dial-up is in progress to the control unit with location number 2. The lower part of the display now toggles the message CALLING and the NAME of the called control unit. During the dialling time of 30 seconds it is possible to hook off the handset and speak into the microphone. As LF is activated in the called control unit during dialling, the receiver of the call can hear you in the speaker without hooking off. This makes it possible to use the VHF system as a sort of paging system.

- If the intercom attempt is answered:
When the receiver of the call hooks off his handset, the intercom is established.



If the intercom attempt is not answered:
If the receiver of the call does not answer the intercom within 30 seconds, the handset automatically hangs up and reenters normal VHF operation.

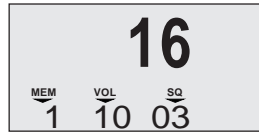

Receiving an intercom attempt from another control unit:

When an intercom is attempted from another control unit to the handset, this will act as illustrated in the following example, where the caller has location number 3.

- Receiving an intercom



The display toggles CALLING and the NAME of the caller. A ringing tone is heard in the speaker.

- To answer the intercom, hook off handset.

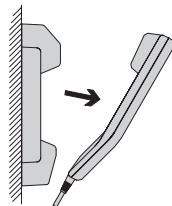

The intercom connection between the two control units is now established; to communicate, simply press PTT and speak into the microphone.

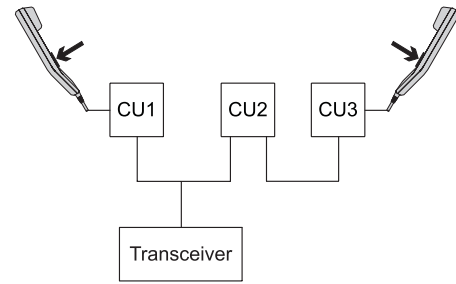

During intercom the handset is able to:

- Adjust volume level
- Mute/unmute speaker
- Adjust squelch level
- Adjust dimmer level

Terminating an intercom session:

The intercom connection can be terminated by either of the control units.

To end an intercom:

- Place handset on hook.
The handset resumes in VHF mode.

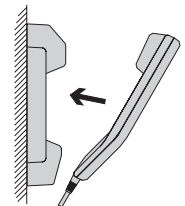

- Key

The handset resumes in VHF mode.

- Key

The handset resumes in VHF mode selecting channel 16.

Full DSC Operation

Receiving DSC Calls

When a DSC call is received, the user will be advised by the handset. This is done in different ways, depending on the type of DSC call and the handset operation mode:

Sound,
CALL indicator lamp or
CALL and ALARM indicator lamps.



Furthermore the handset does as follows:

1. If on hook:

A. If VHF mode active:

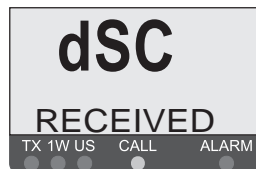

The handset automatically changes to DSC mode and starts toggling limited call information on the display. Ex:

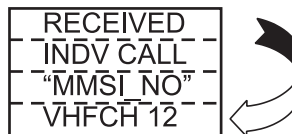

B. If DSC mode or function menu active, the handset continues the function in progress.



2. If hooked off:

A. If VHF mode active:

The handset continues in VHF mode, for your VHF control.

Press  to view the limited call contents as in 1 A.

B. If DSC mode or function menu active:

The handset continues the function in progress.

In all cases, to view all DSC call contents:

Press  and view all call contents by entering the RX LOG menu,

using the key  to step through the call information.

Tone signalling when receiving DSC Calls

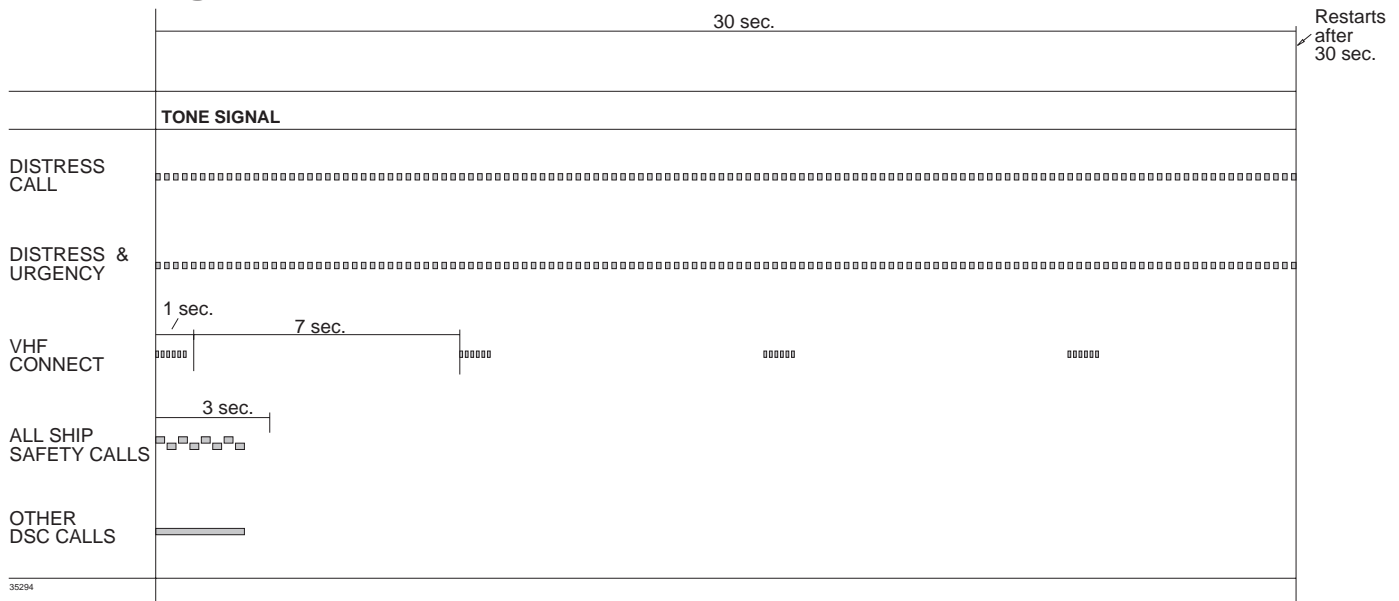

The tone signalling sequence is repeated every 30 seconds or until the DSC call is either read or answered. When handset is hooked off, there is a short tone every 30 seconds until call is read.

RX LOG Menu

The RX LOG menu is used for reading all information on DSC calls received. Also, if requested by a DSC call received, it is possible to set up a DSC acknowledgment call.

The RX LOG menu has the following main menu entries:

1. LAST CALL
When a DSC call has been received and the handset toggles call information, to view all calls and/or answer back, enter this item.
2. ALARM CALL
To view DSC distress calls, and all calls of CATEGORY distress or urgency, enter this item.
3. CALL
To view DSC calls from the VHF DSC modem ordinary calls buffer, CATEGORY safety or routine, enter this item.

The RX LOG Menu Tree

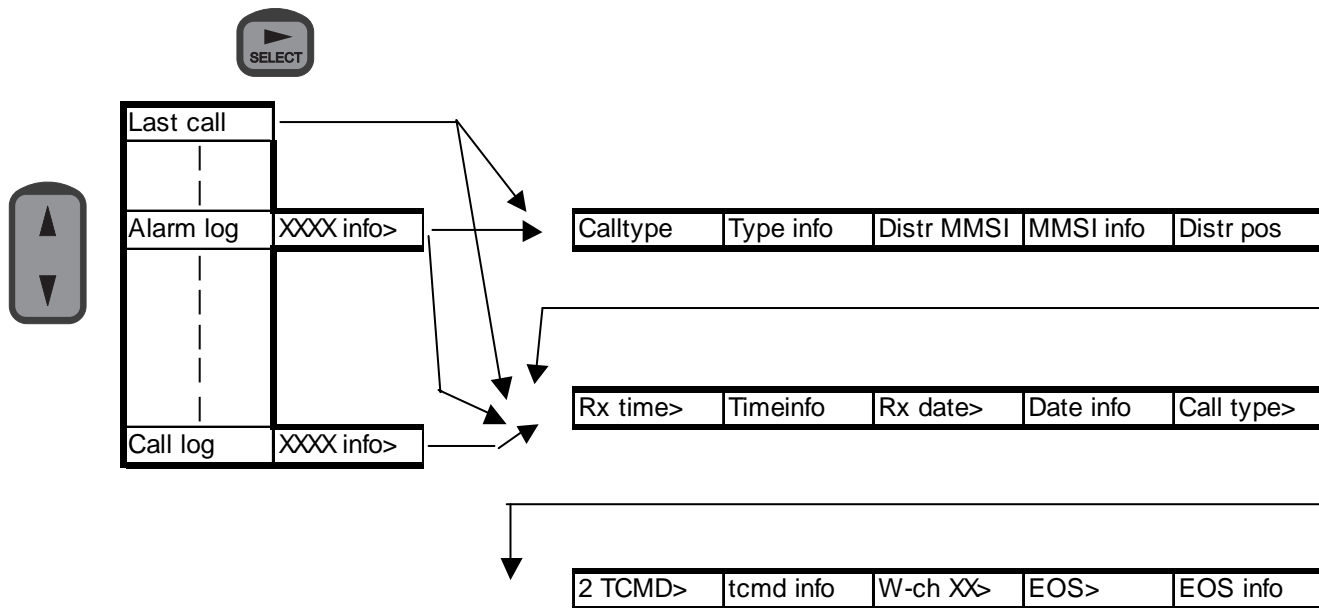

List of abbreviations

1 TCMD	First telecommand
2 TCMD	Second telecommand
Bad-vhfch	Unable to use proposed channel
Call repl	Call replied
CAT info	Specification of category
Com info	Specification of type of distress communication
Congestn	Congestion at maritime switching centre
Distr com	Type of distress communication
Distr MMSI	MMSI number of sender of distress call
Distr Nat	Nature of distress
Distr pos	Position of sender of distress call
Distr time	Time when distress call was sent
EOS	End-of-sequence (character ending call)
EOS = ackn bq	The end-of-sequence character is ending a call sent in reply to a request
EOS = RQ	The end-of-sequence character is ending a request
FS	Format specifier
Info	Information
Lat info	Position latitude information
Long info	Position longitude information
MMSI info	Information on MMSI number

Nat info	Specification of nature of distress
No comply	Unable to comply with what the other party is asking
No opr	No operator available
No reason	Declining to give any reason why you are unable to comply with what the other party is asking
Opr unava	Operator temporarily unavailable
Queueindi	Queue indication
Rx date	Date when call was received
RX	Received (calls)
Rx time	Time when call was received
Stnbarred	Station barred
tcmd info	Telecommand information
Utc	Universal coordinated time (approx. the same as GMT)
W-ch	VHF working channel

The call is too old if time elapsed since rx > 5 mins.

Lat info	Long info	Distr time	Utc XX XX	Distr nat	Nat info	Distr com	Com info
----------	-----------	------------	-----------	-----------	----------	-----------	----------

FS info	Category>	CAT info	From>	MMSI info	1 TCMD>	tcmd info
---------	-----------	----------	-------	-----------	---------	-----------

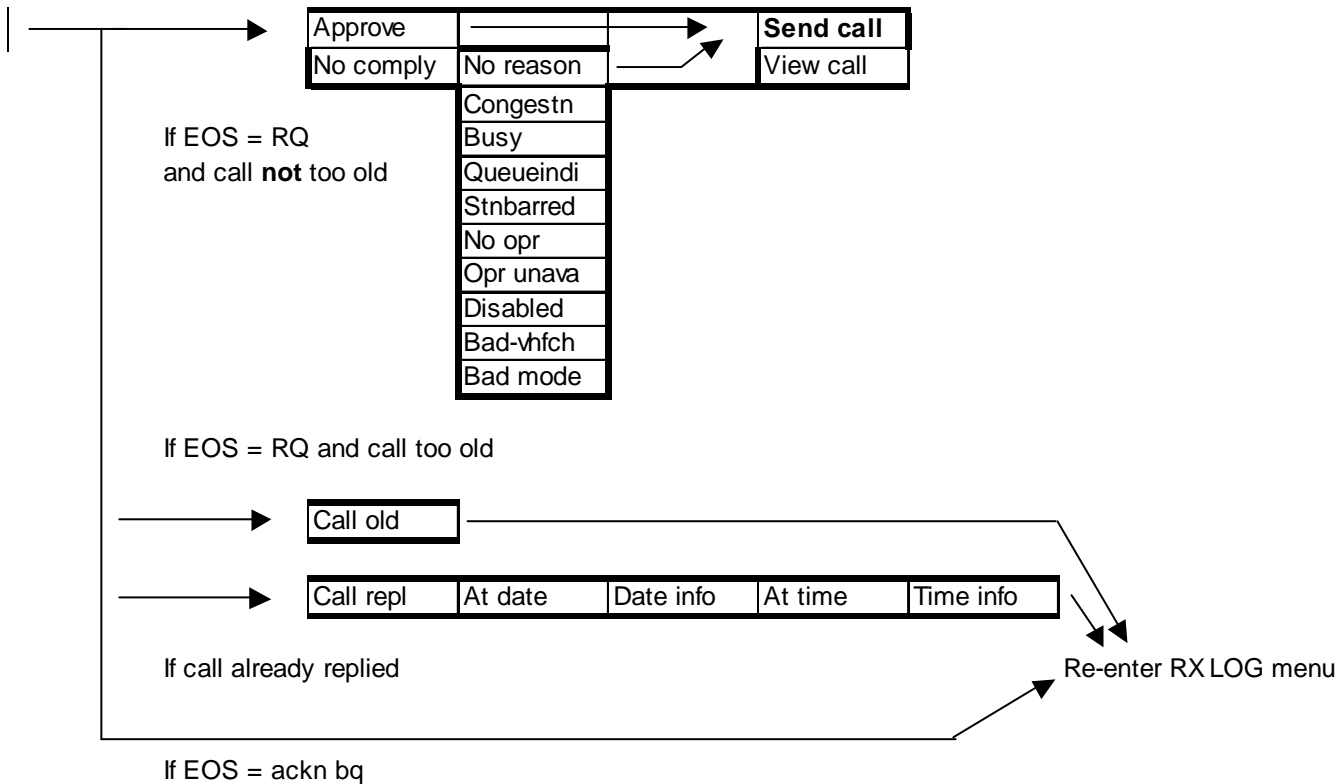

TX CALL Menu

The TX CALL menu offers a variety of possibilities of setting up DSC calls for transmission, from totally manual call setup using the extended calls entry, setting up each piece of information involved in the call, to almost automatic setup of DSC calls using the menu entries ADDR BOOK, SHIP STN, AND SHORE STN. A distress call is set up automatically by pressing the hook distress button.



For manual setup of distress call, use the DISTRESS entry in the TX CALL menu.

TX CALL menu main entries:

1. SHIP STN
Your input: MMSI number or a pre-stored station from the station register, change of working channel if desired.
Call setup: Automatic, individual routine incl. VHF working channel, requests acknowledgment.
If MMSI number of group number (starting with "0"):
Group call incl. VHF working channel.
2. ADDR BOOK
Your input: Pre-stored name from the address book register.
Call setup: Automatic, depending on:
Ship station:
Shore station:
Shore station including telephony number:
3. SHORE STN
Your input: MMSI number or pre-stored station from the station register, optional telephony number.
Call setup: Automatic, depending on:
Telephony number included:
No telephony number included:
4. EXTENDED
Your input: All information in call.
Call setup: As specified by user.
5. DISTRESS
Your input: Nature of distress, position and time. If a GPS is connected, time and position are automatically inserted.
Call setup: A standard distress call.
6. ALL SHIP
Your input: Change of working channel if desired.
Call setup: Automatic.
All ships, safety, incl. VHF working channel.









To navigate in the TX CALL Menu use the keyboard keys:



Setting up a Call from Extended Menu

To illustrate how to set up a DSC call in the TX CALL menu, the following is an example of setting up an individual call using the EXTENDED menu entry.

To enter the TX CALL menu to set up DSC call:

1. Press TX CALL  
2. Press  3 times to find EXTENDED entry. 
3. Press  to enter item (info text) 
4. Press  . Use  to find INDV-STN 

To enter the type of call:



6. Key in the nine digit MMSI number of the ship station or coast station to be called.
Use the keys:



To select MMSI number:

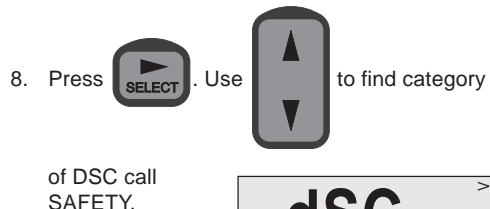
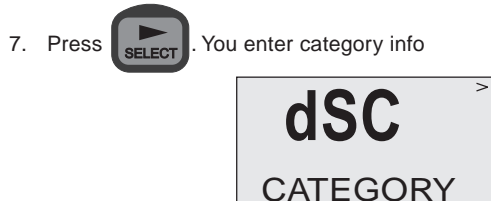

To select the category:

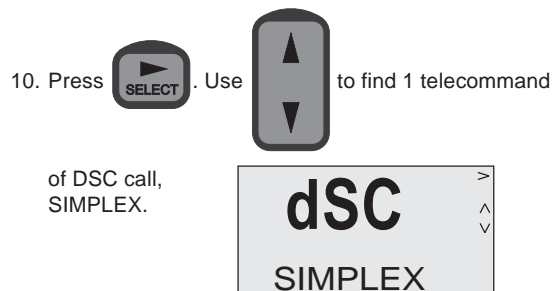

To select 1 telecommand:

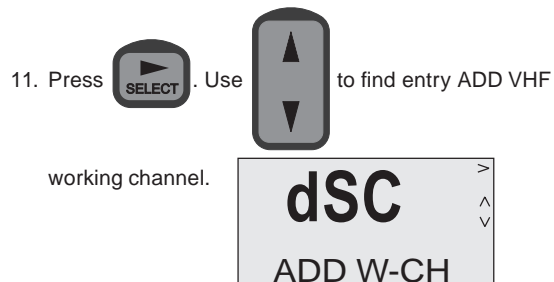

12. Press  and enter VHF working channel (e.g. channel 6).



To select working channel:

13. Press 

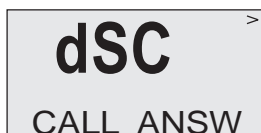

14. Press . Use  to find REQ ANSW item.

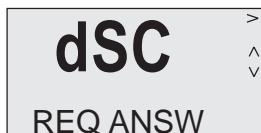

15. Press  to select the item.



To transmit DSC call:

16. Press 



The DSC call having been transmitted, the handset awaits the receiver's call acknowledgment.

TX CALL Menu Tree

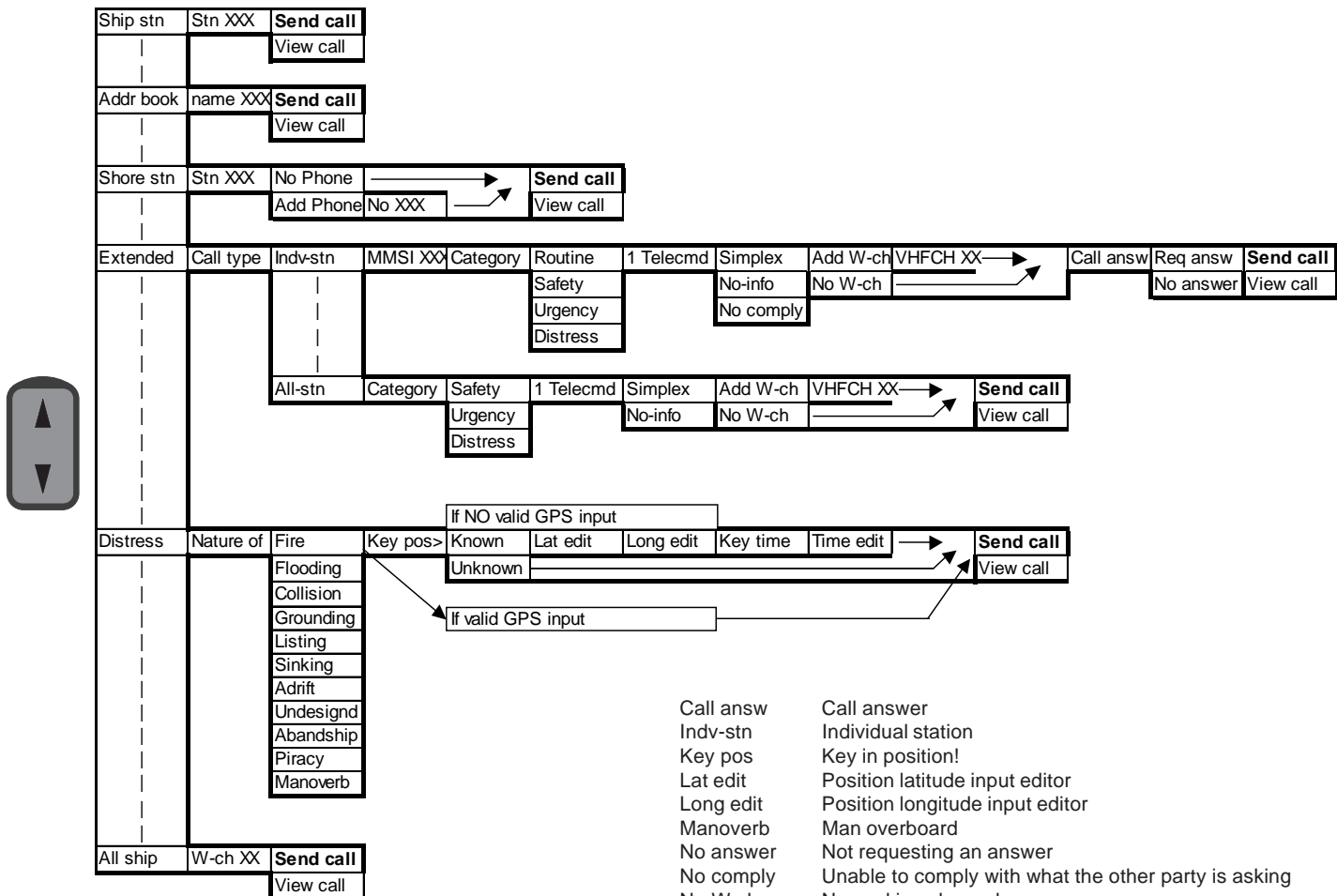

List of abbreviations

1 telecmd First telecommand
 Abandship Abandoning ship
 Add W-ch Additional information: Working channel
 Addr Address
 All-stn All stations

Call answ Call answer
 Indv-stn Individual station
 Key pos Key in position!
 Lat edit Position latitude input editor
 Long edit Position longitude input editor
 Manoverb Man overboard
 No answer Not requesting an answer
 No comply Unable to comply with what the other party is asking
 No W-ch No working channel
 No XXX Phone number
 No-info No information
 Req answ Requesting an answer
 Stn Station
 TX Sent (calls)
 Undesignd Undesignated distress call
 VHFCH VHF channel (working channel)
 W-ch Working channel

Function Menu

The function menu offers facilities to view and set up the functionality of the handset unit. It also offers facilities to view and change functionality of the VHF transceiver and of the DSC modem as well.

To enter the function menu.

To view or set any specific items in the function menu press the keys



To move around in the function menu use the keys:

1. : To set menu entry to be entered.
2. : To enter the entry set in 1.
3. : To reenter the function menu (press for 1 second).

To edit items in the function menu, use the keys:

1. :
 - a. To change option "Y"/"N".
 - b. To change single numeric value, up or downwards until limit.
2. :
 - a. To save/select item setting, entering the next item too.
 - b. To move one step to the right in an item with more inputs.
3. :
 - a. To reenter the function menu (press for 1 second).
 - b. To delete the character to the left of the cursor (moving one step to the left in an item).



- a. To enter an alphanumeric character in the cursor's place.

To leave the function menu:

NB: If any setting has been changed when leaving the function menu, the handset has to be turned off and then on again for the changes to take effect.

The function menu can be left in the following ways:

1. : Activates VHF mode, selecting channel 16



2. : Activate VHF mode

3. : Do 2.



4. : Enters DSC RX-LOG menu

Example:

To activate keyboard “beep” function for keyboard to beep every time a key is pressed.



Enter the function menu

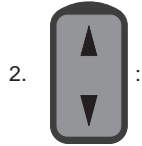

Pushed twice, finds the general entry

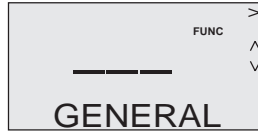

Enters the entry

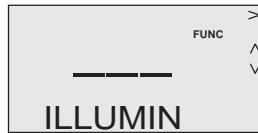

: Finds the entry

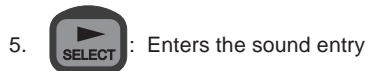
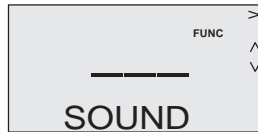

: Enters the sound entry

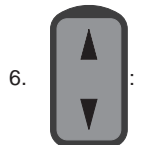
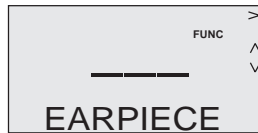

Pushed twice, finds the entry

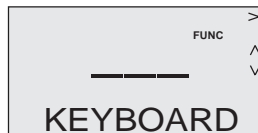

: Enters keyboard entry

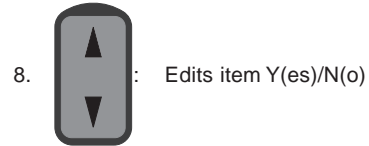
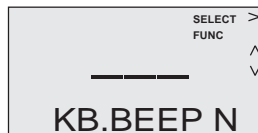

: Edits item Y(es)/N(o)

When Y(es)...



Selects the setting and reenters the function menu



To activate the new settings, turn the handset off and then on again.

Function Menu Item Description

Path:	Data:	Description:
DSC\SETTINGS\ACKNOWLEDG\AUTOACK	"Y"/"N"	"Y" enables autoacknowledgment of DSC calls.
GENERAL\ILLUMIN\INDICATOR\LEVL_0-3	0-3	Light intensity of each indicator lamp dimmer level.
GENERAL\ILLUMIN\DISPLAY\DB_L_0-3	0-9	Light intensity of each display backlight dimmer level.
GENERAL\ILLUMIN\DIMMER\D_LEVL	0-3	Dimmer level when handset is turned on.
GENERAL\ILLUMIN\DIMMER\D_LEVL\DIMDIR	0-2	Dimmer level start direction (see diagram on next page).
GENERAL\ILLUMIN\KEYBOARD\SECS	0-20	Number of seconds that handset light is on after a key has been pushed.
GENERAL\ILLUMIN\KEYBOARD\SECS\D_LEVL	0-3	Dimmer level when any key has been pushed (provided number of seconds in item above is 1 or more)
GENERAL\SOUND\EARPIECE\NORM	0-15	Earpiece normal volume level when handset is turned on.
GENERAL\SOUND\EARPIECE\NORM\ALARM	0-15	Earpiece alarm volume level when receiving DSC call or intercom.
GENERAL\SOUND\LOUDSPEAK\NORM	0-15	Speaker normal volume level when handset is turned on.
GENERAL\SOUND\LOUDSPEAK\NORM\ALARM	0-15	Speaker alarm volume level when receiving DSC call or intercom.
GENERAL\SOUND\LOUDSPEAK\NORM\ALARM\EXT_SPK	0-3	Handset control of external speaker.
GENERAL\SOUND\LOUDSPEAK\NORM\ALARM\EXT_SPK\HO_SPK	0-1	Speaker state when handset is hooked off. Default on=1 or off=0.
GENERAL\SOUND\KEYBOARD\KBBEEP	"Y"/"N"	Keyboard key beep when pushing key.
GENERAL\SOUND\SIDETONE\ST ATT	0-3	Feedback level of microphone to earpiece (recommended setting=1).
SERVICE\DSC\SELF-ID\GRPEDIT	0-9	Group MMSI number setup / change
SERVICE\TELEPHONY\CH+MODE\INPUTS	"Y"/"N"	Setup of number of input digits when changing VHF channel. Y = 3 digits, N = 2 digits

The dimmer start direction can be set up in three different ways:

Start direction 0:

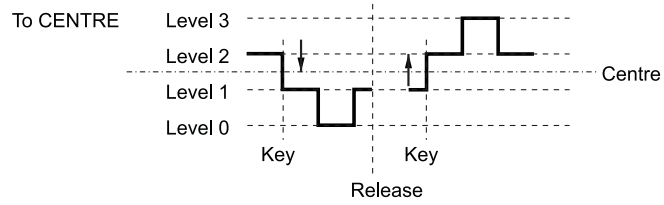

Start direction 1:

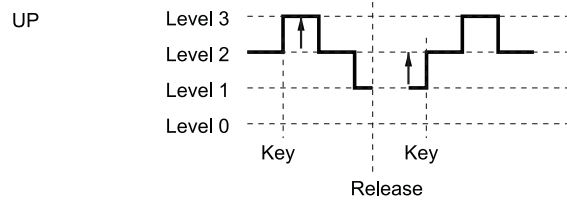

Start direction 2:

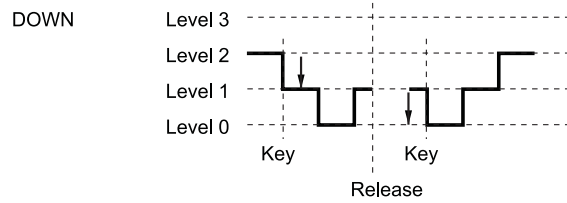

FUNCTION Menu Tree



Telephony	Scanner	Mem_no X	Name XXX	Pr-ch XX	Pr_sc X							
	Squelch	Mode X										
	Atis no	XXXXXXXXX										
Dsc	Settings	Self-id	MMSI-NU>	XXXXXXXXXX	GrpMMSI	XXXXXXXXXX						
		Position	Posview	X:XXXX	X:XXXXX	Utc time	Utc XX:XX					
			Pos auto	X:XXXX	X:XXXXX							
			Pos mode	Show X								
			Posupdate	X:XXXX	X:XXXXX	AT Utc	HXX MXX					
		Acknowldg	Autoack X									
		Time date	View	Tzone XX	Localtime	XX XX XX	Date	XX XX XX				
			Set	Tzone XX	Utctime	Hour XX	Mins XX	Secs XX	Date	Year XX	Month XX	Day XX
	Addr book	Add name	Name XXXX	Mmsi XXX	Phone XXX	Phone XXX	Press sto					
		View del	Name XXXX	Mmsi XXX	Phone XXX	Phone XXX						
		If coast stn, phone number can be added for public call										
	Directory	Add stn	Name XXXX	Mmsi XXX	Press sto							
		View del	Name XXXX	Mmsi XXX								
	Testcalls	Int path										
		Ext path										
General	Illumin	Indicator	Levl_0 X	Levl_1 X	Levl_2 X	Levl_3 X						
		Display	Levl_0 X	Levl_1 X	Levl_2 X	Levl_3 X						
		Dimmer	D_levl X	D_dir X								
		Keyboard	Secs XX	D_levl X								
	Sound	Earpiece	Norm XX	Alarm XX								
		Loudspeak	Norm XX	Alarm XX	Extspk X	Ho spk X						
		Keyboard	Beep X									
		Sidetone	St att X									
	Version	Handset	Software	XXXXXX	Serial no	XXXXXXXXXX						
		Transceiv	Software	XXXXXX	Serial no	XXXXXXXXXX						
Service	Code	Bus setup	Handset	Loc no X	Name XXXX							
		DSC	Self-id	GRP edit	XXXXXXXXXX							
		Telephony	CH_mode	Input 3 x								

Directory Setup









The directory is a subset of the DSC items in the function menu. In the function menu it is possible to programme the stations used most frequently for future use in the TX CALL menu. If not used frequently a station may be erased from the function menu.



The directory makes it possible to set up DSC calls fast and easily using the SHIP or SHORE items in the DSC TX CALL menu, selecting an MMSI number by looking up the connected identification name.

The directory offers the connection of an identification NAME to an MMSI number.

Adding an item to the directory:

To set up an item in the directory, enter the function menu:

1.   to enter the function menu

2.  to find the DSC entry

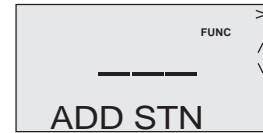
3.  Then use  to find DIRECTORY entry

4.  Then use  to find ADD STN entry

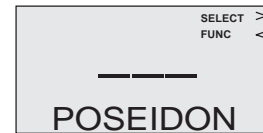

5.  : 

6. Enter the name of the new item.
 Always enter nine characters - letters or spaces. If the name contains less letters, insert spaces (by pushing the "0" key) until nine characters have been entered.



Select the input

7.  : 

8. Enter the MMSI number of the new item

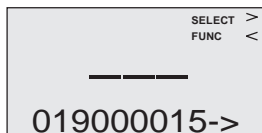

Select the input

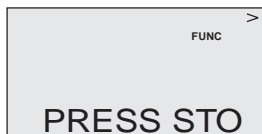

Store name and MMSI number:

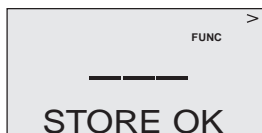

Now the name and MMSI number are stored in the memory of the DSC modem and can be used in the TX CALL MENU by looking up the name to select destination station MMSI number of the DSC call.

Viewing and deleting an item from the directory:

To view and maybe delete an item from the directory, enter the function menu. Use the keys:

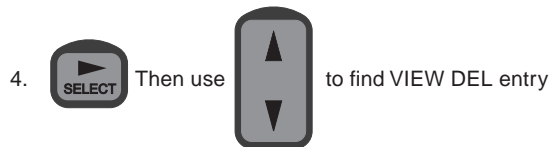
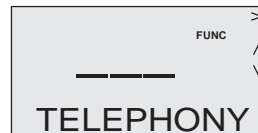



5. The last station name used will appear on the display

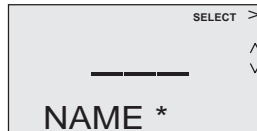

6. a. To view other station names in register, going through the

various items:

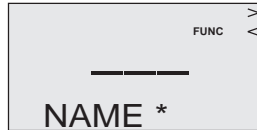

- b. To view MMSI number:



- c. To delete the item when the name is displayed:

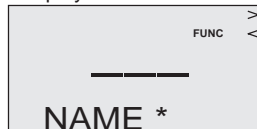

When an item has been deleted the next item in memory is displayed. If no more items:

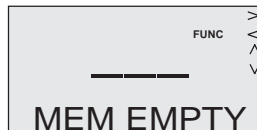

ADDR BOOK Setup

The ADDR BOOK is a subset of the DSC items in the function menu. The ADDR BOOK is very similar to the directory, though it offers the extra facility that in addition to an identification name, a public telephone number can be added to an MMSI number if this is a coast station number.

The ADDR BOOK makes it possible to set up DSC calls fast and easily using the ADDR BOOK item in the DSC TX CALL menu.

The ADDR BOOK setup functions in the same way as the directory setup, the only difference being that a public telephone number can be added to the name. The procedure is similar to the station register setup; just enter the function\dsc\ADDR BOOK.

VHF System Description

To the VHF system can be connected up to 7 control units. Each control unit has a unique location (1-7). If a control unit wants to control the transceiver, it has to be master of the system. The following describes the display read-outs shown in connection with different system priorities of the control units:

The control unit assigned location number 1 has the highest priority in the VHF system and is able to become master of the system at any time needed.

When more control units are connected to the VHF system, the main control unit has to be assigned location number 1.

When the system is free:

If a handset is in VHF mode, the display will show:



If a handset is in DSC mode or the function menu is active, the display shows the menu item.



When a control unit is master of the system, the other control units, if in VHF mode, show the following display to indicate that the transceiver is in use by another control unit:

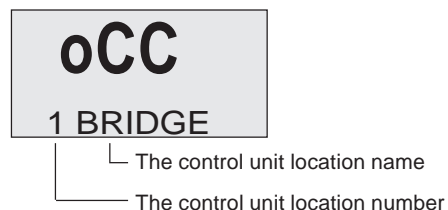

If the other control units are in DSC mode or the function menu is active, the display will show the menu item as usual.



Getting the MASTER priority in the system:

To operate the transmitter, the handset has to be master of the system. To become master of the system, simply hook off the handset.

When the handset becomes master of the system, the display will not change.

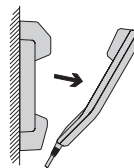

If the handset does not become master of the system and the handset is operated in VHF mode, the display will show the message:



If the system is occupied by another control unit, hang up and wait for the system to become free.

International Channels

Channels	TX MHz	RX MHz	SIMPLEX		DUPLEX	
			Intership	Port	Port	Public
1	156,050	160,650			●	●
2	156,100	160,700			●	●
3	156,150	160,750			●	●
4	156,200	160,800			●	●
5	156,250	160,850			●	●
6	156,300	156,300	●			
7	156,350	160,950			●	●
8	156,400	156,400	●			
9	156,450	156,450	●	●		
10	156,500	156,500	●	●		
11	156,550	156,550		●		
12	156,600	156,600		●		
13	156,650	156,650	●	●		
14	156,700	156,700		●		
15	156,750	156,750	●	●		
16	156,800	156,800	Distress and calling			
17	156,850	156,850	●	●		
18	156,900	161,500			●	●
19	156,950	161,550			●	●
20	157,000	161,600			●	●
21	157,050	161,650			●	●
22	157,100	161,700			●	●
23	157,150	161,750			●	●
24	157,200	161,800			●	●
25	157,250	161,850			●	●
26	157,300	161,900			●	●
27	157,350	161,950			●	●
28	157,400	162,000			●	●

Channels	TX MHz	RX MHz	SIMPLEX		DUPLEX	
			Intership	Port	Port	Public
60	156,025	160,625			●	●
61	156,075	160,675			●	●
62	156,125	160,725			●	●
63	156,175	160,775			●	●
64	156,225	160,825			●	●
65	156,275	160,875			●	●
66	156,325	160,925			●	●
67	156,375	156,375	●	●		
68	156,425	156,425		●		
69	156,475	156,475	●	●		
70	156,525	156,525	DSC	DSC		
71	156,575	156,575		●		
72	156,625	156,625	●			
73	156,675	156,675	●	●		
74	156,725	156,725		●		
75	156,775	156,775		● L)		
76	156,825	156,825		● L)		
77	156,875	156,875	●			
78	156,925	161,525			●	●
79	156,975	161,575			●	●
80	157,025	161,625			●	●
81	157,075	161,675			●	●
82	157,125	161,725			●	●
83	157,175	161,775			●	●
84	157,225	161,825			●	●
85	157,275	161,875			●	●
86	157,325	161,925			●	●
87	157,375	157,375		● *)		
88	157,425	157,425		● *)		

Notes:

L) 1 W TX power.

*) Due to the introduction of the channels AIS1 at 161.975 MHz and AIS2 at 162.025 MHz for Automatic Identification System, channels 87 and 88 became simplex channels as of 1 January 1999.

NB! The RX and TX frequencies can be read out on the control unit handset display by pressing (for more than one second) and holding the CH key.
At a front-operated VHF radio, the RX and TX frequencies can be displayed on a menu.

US Channels

Channels	TX MHz	RX MHz	SIMPLEX	DUPLEX
1	156,050	156,050	●	
2				B)
3	156,150	156,150	● !)	
4				B)
5	156,250	156,250	●	
6	156,300	156,300	●	
7	156,350	156,350	●	
8	156,400	156,400	●	
9	156,450	156,450	●	
10	156,500	156,500	●	
11	156,550	156,550	●	
12	156,600	156,600	●	
13	156,650	156,650	● L)	
14	156,700	156,700	●	
15		156,750	● RX)	
16	156,800	156,800	Distress and calling	
17	156,850	156,850	●	
18	156,900	156,900	●	
19	156,950	156,950	●	
20	157,000	157,000	●	
21	157,050	157,050	● !)	
22	157,100	157,100	●	
23	157,150	157,150	● !)	
24	157,200	161,800		●
25	157,250	161,850		●
26	157,300	161,900		●
27	157,350	161,950		●
28	157,400	162,000		●

Channels	TX MHz	RX MHz	SIMPLEX	DUPLEX
60				B)
61	156,075	156,075	● !)	
62				B)
63	156,175	156,175	●	
64	156,225	156,225	● !)	
65	156,275	156,275	●	
66	156,325	156,325	●	
67	156,375	156,375	● L)	
68	156,425	156,425	●	
69	156,475	156,475	●	
70	156,525	156,525	DSC	
71	156,575	156,575	●	
72	156,625	156,625	●	
73	156,675	156,675	●	
74	156,725	156,725	●	
75			B)	
76			B)	
77	156,875	156,875	● L)	
78	156,925	156,925	●	
79	156,975	156,975	●	
80	157,025	157,025	●	
81	157,075	157,075	● !)	
82	157,125	157,125	● !)	
83	157,175	157,175	● !)	
84	157,225	161,825		●
85	157,275	161,875		●
86	157,325	161,925		●
87	157,375	161,975		●
88	157,425	157,425	●	

Channels	WX	RX MHz
P1	WX1	162,550
P2	WX2	162,400
P3	WX3	162,475
P4	WX4	162,425
P5	WX5	162,450
P6	WX6	162,500
P7	WX7	162,525
P8	WX8	161,650
P9	WX9	161,775
P10	WX10	163,275

Notes:

- L) 1 W TX power. By pressing the 25W button in the US hook, the transmitter will transmit at 25W on channel 13 and 67, which are normally limited to 1W transmission.
- B) Channels 2, 4, 60, 62, 75 and 76 cannot be selected in US mode.
- !) Channels 3, 21, 23, 61, 64, 81, 82 and 83 may be legally used in certain instances, but they are not for use by the general public in US waters.
- RX) Only RX. Transmitter is blocked.
- NB!) The RX and TX frequencies can be read out on the control unit handset display by pressing (for more than one second) and holding the CH key.
At a front-operated VHF radio, the RX and TX frequencies can be displayed on a menu.

BI Channels

Channels	TX MHz	RX MHz	SIMPLEX		DUPLEX	
			Intership	Port	Port	Public
1	156,050	160,650			●	●
2	156,100	160,700			●	●
3	156,150	160,750			●	●
4	156,200	160,800			●	●
5	156,250	160,850			●	●
6	156,300	156,300	● L)			
7	156,350	160,950			●	●
8	156,400	156,400	● L)			
9	156,450	156,450	●	●		
10	156,500	156,500	● L)	● L)		
11	156,550	156,550		● L)		
12	156,600	156,600		● L)		
13	156,650	156,650	● L)	● L)		
14	156,700	156,700		● L)		
15	156,750	156,750	● L)	● L)		
16	156,800	156,800	Distress and calling			
17	156,850	156,850	● L)	● L)		
18	156,900	161,500			●	●
19	156,950	161,550			●	●
20	157,000	161,600			●	●
21	157,050	161,650			●	●
22	157,100	161,700			●	●
23	157,150	161,750			●	●
24	157,200	161,800			●	●
25	157,250	161,850			●	●
26	157,300	161,900			●	●
27	157,350	161,950			●	●
28	157,400	162,000			●	●

Channels	TX MHz	RX MHz	SIMPLEX		DUPLEX	
			Intership	Port	Port	Public
60	156,025	160,625			●	●
61	156,075	160,675			●	●
62	156,125	160,725			●	●
63	156,175	160,775			●	●
64	156,225	160,825			●	●
65	156,275	160,875			●	●
66	156,325	160,925			●	●
67	156,375	156,375	●	●		
68	156,425	156,425		●		
69	156,475	156,475	●	●		
70	156,525	156,525	DSC	DSC		
71	156,575	156,575		● L)		
72	156,625	156,625	● L)			
73	156,675	156,675	●	●		
74	156,725	156,725		● L)		
75	156,775	156,775		B)		
76	156,825	156,825		B)		
77	156,875	156,875	● L)			
78	156,925	161,525			●	●
79	156,975	161,575			●	●
80	157,025	161,625			●	●
81	157,075	161,675			●	●
82	157,125	161,725			●	●
83	157,175	161,775			●	●
84	157,225	161,825			●	●
85	157,275	161,875			●	●
86	157,325	161,925			●	●
87	157,375	157,375		● *)		
88	157,425	157,425		● *)		

Notes:

- B)** Channels 75 and 76 cannot be selected in BI mode.
 - L)** 1W TX power on channels 6, 8, 10, 11, 12, 13, 14, 15, 17, 71, 72, 74, and 77.
 - *)** Due to the introduction of the channels AIS1 at 161.975 Mhz and AIS2 at 162.025 MHz for Automatic Identification System, channels 87 and 88 became simplex channels as of 1 January 1999.
- NB!** - The ATIS function is enabled on all channels.
 - The RX and TX frequencies can be read out on the control unit handset by pressing (for more than one second) and holding the CH key.
 At a front-operated VHF radio, the RX and TX frequencies can be displayed on a menu.



SAILOR® · Porsvej 2 · PO Box 7071 · DK-9200 Aalborg SV · Denmark
Phone: +45 9634 6100 · Fax: +45 9634 6101 · Telex: 69789 ECI DK
E-mail: sailor@sailor.dk · Web: www.sailor.dk